

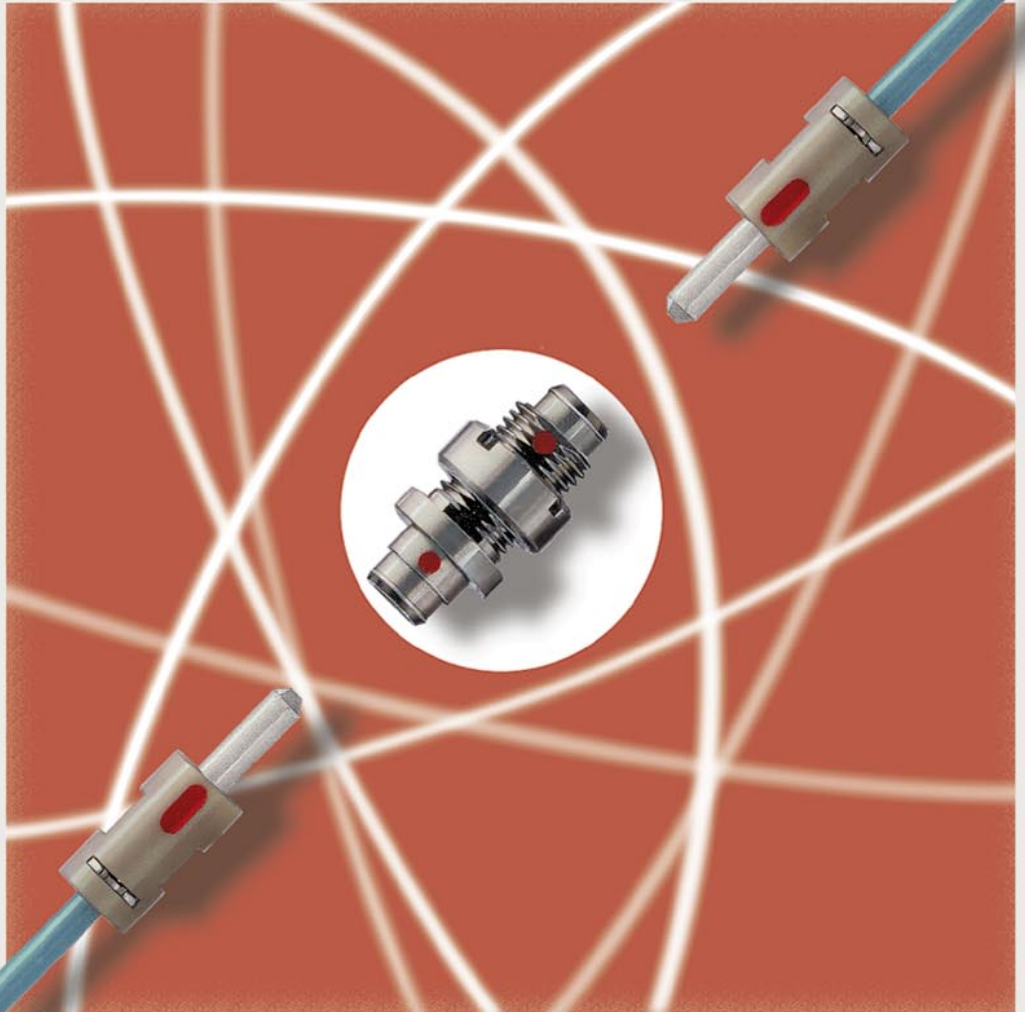

REDEL®



Fiber Optic Connectors D Series



Scale 1:1

INTRODUCTION / EINFÜHRUNG

The REDEL D is an extremely small fibre optic connector which is ideal for use in very confined areas. It uses materials which are compatible with radioactive environments. Its low mass makes it an ideal choice for avionics use, in particle physics research, telecommunications and data communications applications.

Features

- Sub-miniature size
- Low mass
- Push-Pull snap-on fastening system
- Compatible with TO-18 transmitter/emitter components
- Very low insertion loss for both multimode and singlemode
- Fully floating ferrule
- Simple termination

Die REDEL Steckverbindung D hat extrem kleine Abmessungen und ist somit für spezielle Anwendungsgebiete geeignet. Die ausgewählten Materialien sind strahlenbeständig und haben ein geringes Eigengewicht. Der ideale Einsatzfall liegt auf den Sektor Luft und Raumfahrt, der Kernphysik, in der Telekommunikation und der Datentechnik.

Merkmale

- Kleinste Abmessungen
- Geringes Gewicht
- Push-Pull Schnapp - Verriegelung
- Kompatibel mit Bauteilen von Sender/Empfänger TO-18
- Sehr geringe Einfügungsdämpfung sowohl für Multimode als auch für Singlemode
- Freischwimmende Ferrule
- Einfache Bedienung

INTERCONNECTION / STECKBEISPIELE

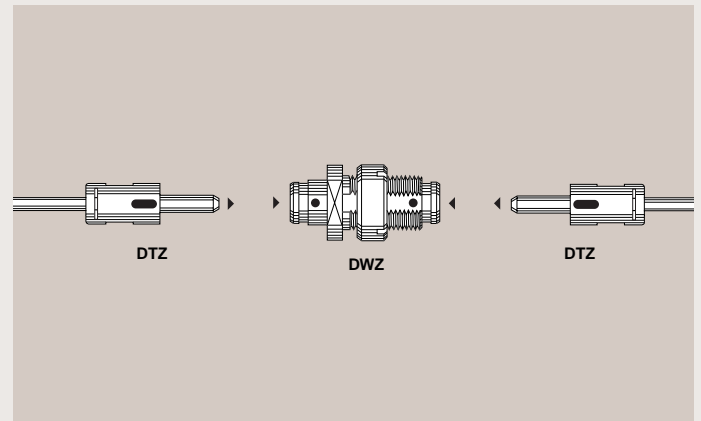
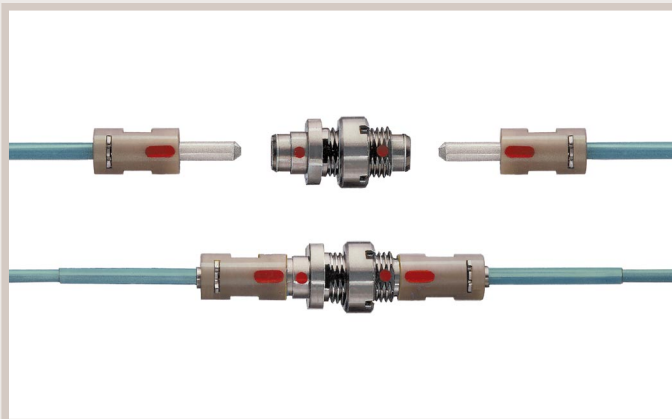

PART SECTION SHOWING INTERNAL COMPONENT / KONSTRUKTIONSAUFBAU

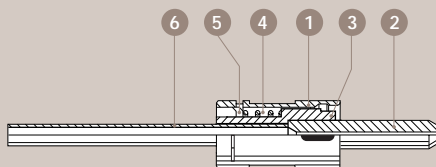

Straight plug / Gerade Stecker

- 1 Outer shell / Aussenkörper
- 2 Ferrule / Ferrule
- 3 Ferrule holder / Ferrulehalter
- 4 Spring / Ring
- 5 Spring retainer / Ringverschluss
- 6 Protection tube / Schutzrohr

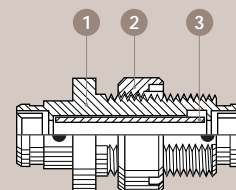

Straight fixed coupler / Gerade Kupplung

- 1 Outer shell / Aussenkörper
- 2 Round nut / Rundmutter
- 3 Alignment device / Führungszylinder

MODELS / BAUFORMEN

DTZ Straight plug for 250 µm coated fibre and 900 µm tight buffered fibre Gerader Stecker für 250 µm Anschlag und 900 µm angeschlagene Faser

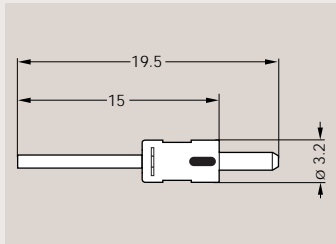
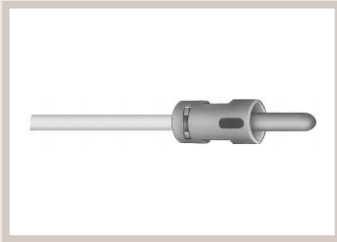

Part Number Bestell-Nr.	Fibre type Faser-Typ	Ferrule hole ø Ferrule Bohrung ø	Weight (g) Gewicht (g)
DTZ.125.GAET06	9/125 singlemode	125	< 0.2
DTZ.126.GAET06	50/125 multimode	126	
DTZ.127.GAET06	62.5/125 multimode	127	

DWZ Straight fixed coupler Gerade Kupplung

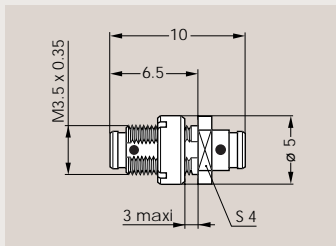
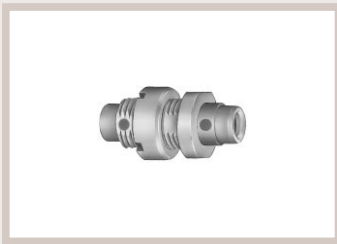

Part Number Bestell-Nr.	Weight (g) Gewicht (g)
DWZ.F99.SA	< 0.7

All dimensions are in mm
Alle Abmessungen in mm

TYPICAL OPTICAL PERFORMANCE DATA / STANDARD OPTISCHE EIGENSCHAFTEN

Characteristic / Kennwert	Value / Wert	Condition / Bedingung
Insertion loss fibre 9/125 Einfügungsverlust Faser 9/125	Mean/Stand. ≤ 0.25 dB	UPC machine polish
Return loss fibre 9/125 Reflexionsverlust Faser 9/125	Mean/Stand. > 45 dB	UPC machine polish
Mating endurance Belastbarkeit	30 cycles/Zyklen	-
Change of insertion loss Einfügungsverlust Abweichung	≤ 0.1 dB	Temperature cycling/Zyklus -20 to +80°C

TOOLS / WERKZEUGE

DCS Microscope adapter Mikroskopadapter

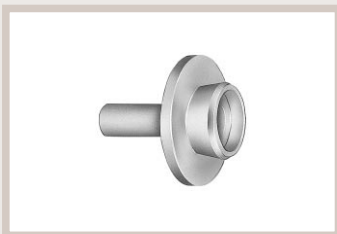

Part Number Bestell-Nr.
DCS.91.G12.5C

DRV Termination workstation Werkzeugkoffer



Part Number Bestell-Nr.
DRV.91.RD1.2PN

DCS Polishing tool Polierhalter



Part Number Bestell-Nr.
DCS.91.D01.LC

TOOLS / WERKZEUGE

DCC Insertion-extraction tool Ausstosswerkzeuge



Part Number Bestell-Nr.
DCC.91.517.0L

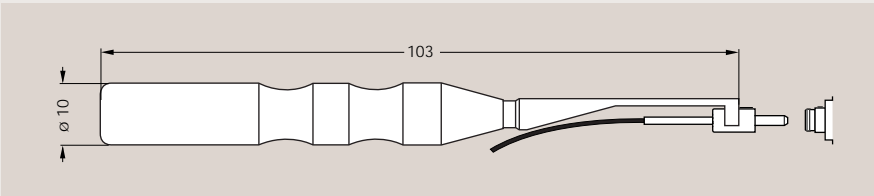

DCC Nutdriver Schraubenzieher



Part Number Bestell-Nr.
DCC.91.518.0L

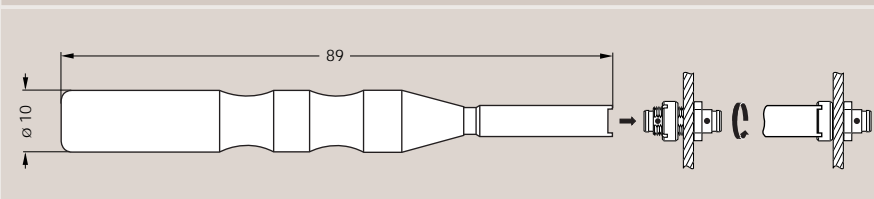

All dimensions are in mm
Alle Abmessungen in mm

COUPLER PANEL CUT-OUT / FRONTPLATTENBOHRUNG FÜR KUPPLUNG

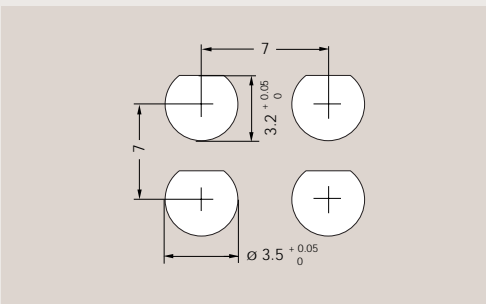

Note: Fixing nut tightening torques: 0.5 Nm (1 N = 0.102 kg)
Anziehdrehmoment: 0.5 Nm (1 N = 0.102 kg)

Distributed by:



Chemin des Champs-Courbes 28
P.O. Box 194
CH-1024 Ecublens (SWITZERLAND)
Telephone: (+41 21) 695 16 00
Telefax: (+41 21) 695 16 01
<http://www.lemo.com>

© LEMO SA. Reproduction or use of editorial and/or pictorial content without express permission is strictly prohibited.
LEMO SA reserves the right to modify and/or improve product specifications at any time without notification.